



Food Waste Disposer Installation, Care & Use Manual

TOOLS & MATERIALS YOU MAY NEED: Slotted Screwdriver, Adjustable Pliers, Electrical Tape...

Read through the entire Installation, Care & Use manual before installing the disposer. Determine which of the tools, materials, and accessories you will need before you begin.

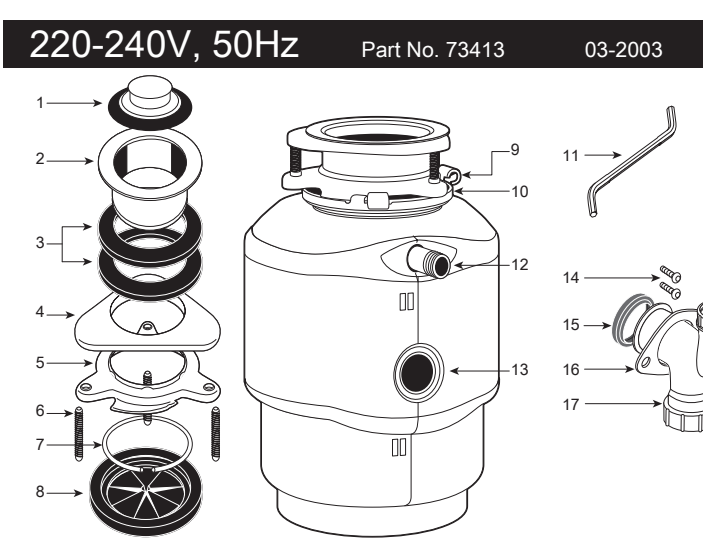
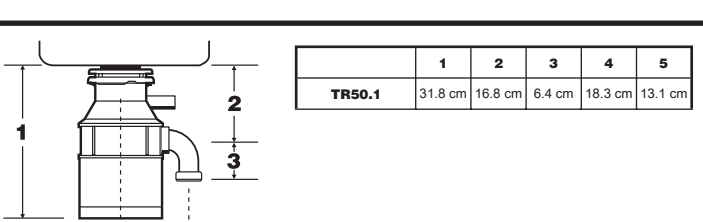
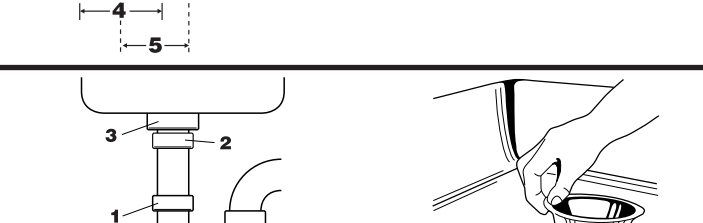

Table with 3 columns: PARTS LIST, MOUNTING ASSEMBLY, DISCHARGE ASSEMBLY

SAFETY SYMBOLS: DANGER indicates an imminently hazardous situation which, if not avoided, will result in death or serious injury.



4. CHECK INSTALLATION DIMENSIONS: 1. Disposer Height: Measure from bottom of sink bowl to center of discharge outlet.



2. DISCONNECT SINK DRAIN: 1. Loosen nut (1) at top of trap (4) with pipe wrench (see Figure 2.1).

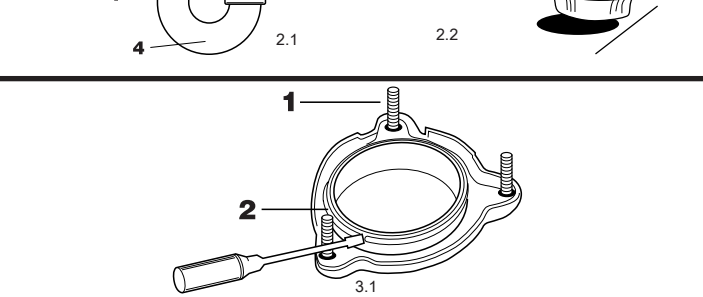

3. DISASSEMBLE NEW DISPOSER MOUNTING ASSEMBLY: 1. Lay disposer on its side and install screwdriver into dishwasher inlet to rest pins on outer edge of knockout plug.

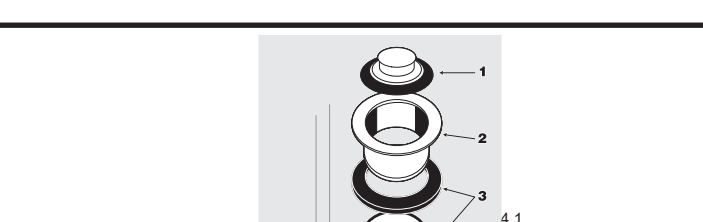

4. ATTACH UPPER MOUNTING ASSEMBLY TO SINK: 1. Place one of two upper gasket (3) under sink flange (2). Ensure sink hole area is clear of debris and place sink flange/gasket into sink hole.

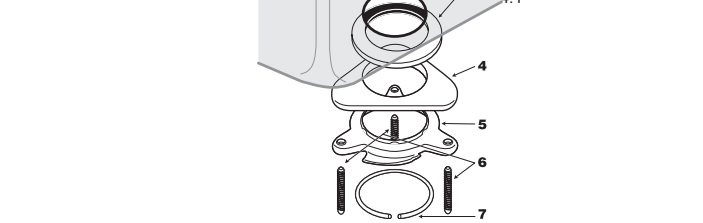

5. CLEAN SINK DRAIN LINE: Failure to clean sink drain line may result in drain line blockage. 1. Remove trap: With drain auger, clear away all hardened waste material in horizontal drain line running from drain trap to main pipe.



6. DISHWASHER ATTACHMENT AND OVERFLOW CONNECTION: Washwater from a dishwasher can be pumped into the disposer through the inlet access on the upper part of the disposer. Note: To prevent backflow and dishwasher contamination, make sure that dishwasher recirculation is disabled before connecting to disposer.

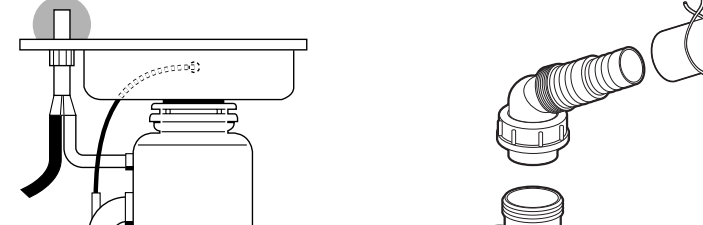

7. CONNECT DISPOSER TO ELECTRICAL SUPPLY: DANGER: Electric Shock. Do not connect power before installing or servicing disposer.

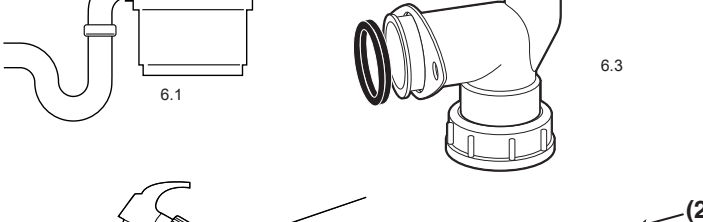

7. LIGAR O TRITURADOR À CORRENTE: PERIGO: Choques eléctricos. Não conecte o tritador a corrente elétrica antes de instalar o tritador.

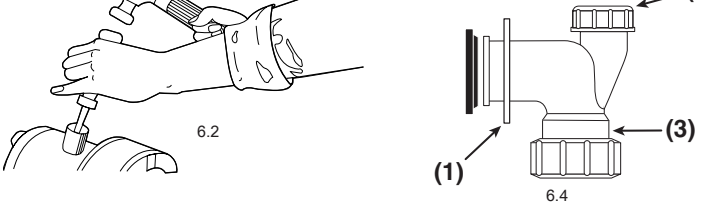

7. CONECTAR EL TRITURADOR AL SUMINISTRO ELÉCTRICO: PELIGRO: Descarga eléctrica. No conecte el tritador a la corriente eléctrica antes de instalar o reparar el tritador.

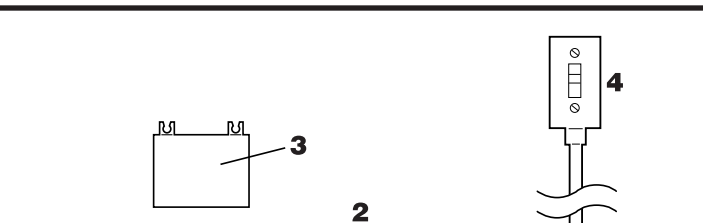

7. INSTALAR O TUBO DE DESCARGA AO ESQ. TOPO: 1. Encava a válvula de metal (1) no tubo de descarga (2). Introduza a junta de borracha (3) no tubo de descarga.

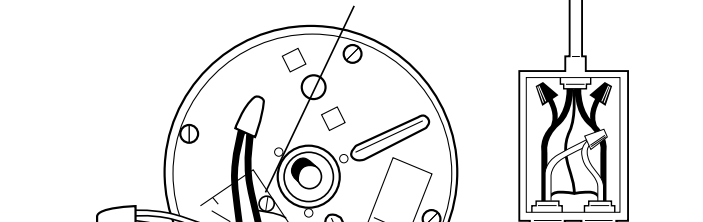

7. CONECTAR EL TRITADOR A LA UNIDAD DE MONTAJE: Precaución: Descarga eléctrica. Retire cualquier objeto que esté dentro de la cámara del triturador antes de instalar el triturador en el fregadero.

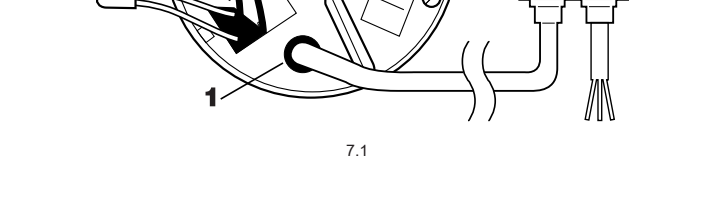

7. CONECTAR EL TRITADOR A LA UNIDAD DE MONTAJE: Precaución: Descarga eléctrica. Retire cualquier objeto que esté dentro de la cámara del triturador antes de instalar el triturador en el fregadero.

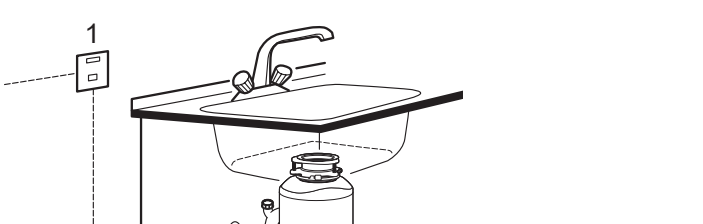

7. CONECTAR EL TRITADOR A LA UNIDAD DE MONTAJE: Precaución: Descarga eléctrica. Retire cualquier objeto que esté dentro de la cámara del triturador antes de instalar el triturador en el fregadero.

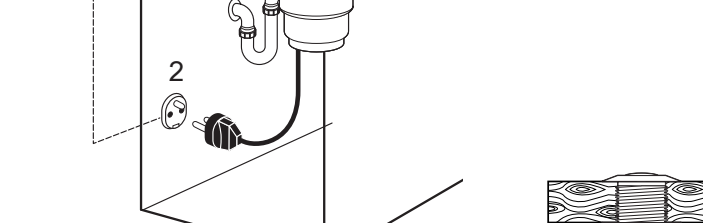

7. CONECTAR EL TRITADOR A LA UNIDAD DE MONTAJE: Precaución: Descarga eléctrica. Retire cualquier objeto que esté dentro de la cámara del triturador antes de instalar el triturador en el fregadero.

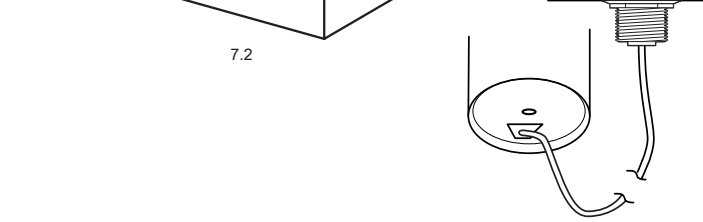

7. CONECTAR EL TRITADOR A LA UNIDAD DE MONTAJE: Precaución: Descarga eléctrica. Retire cualquier objeto que esté dentro de la cámara del triturador antes de instalar el triturador en el fregadero.

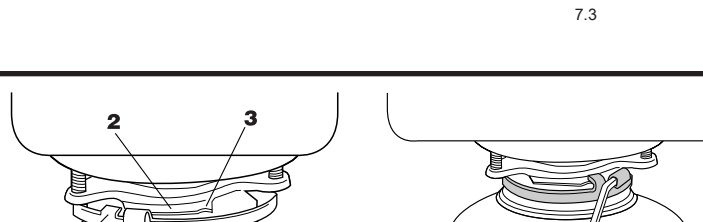

7. CONECTAR EL TRITADOR A LA UNIDAD DE MONTAJE: Precaución: Descarga eléctrica. Retire cualquier objeto que esté dentro de la cámara del triturador antes de instalar el triturador en el fregadero.



7. CONECTAR EL TRITADOR A LA UNIDAD DE MONTAJE: Precaución: Descarga eléctrica. Retire cualquier objeto que esté dentro de la cámara del triturador antes de instalar el triturador en el fregadero.

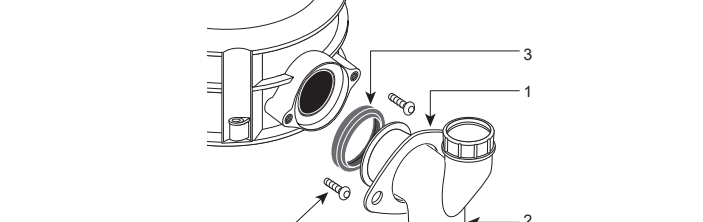

7. CONECTAR EL TRITADOR A LA UNIDAD DE MONTAJE: Precaución: Descarga eléctrica. Retire cualquier objeto que esté dentro de la cámara del triturador antes de instalar el triturador en el fregadero.

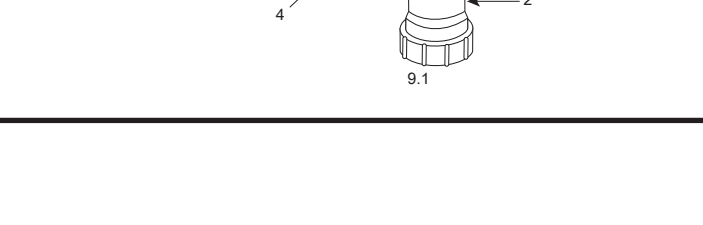

7. CONECTAR EL TRITADOR A LA UNIDAD DE MONTAJE: Precaución: Descarga eléctrica. Retire cualquier objeto que esté dentro de la cámara del triturador antes de instalar el triturador en el fregadero.



7. CONECTAR EL TRITADOR A LA UNIDAD DE MONTAJE: Precaución: Descarga eléctrica. Retire cualquier objeto que esté dentro de la cámara del triturador antes de instalar el triturador en el fregadero.

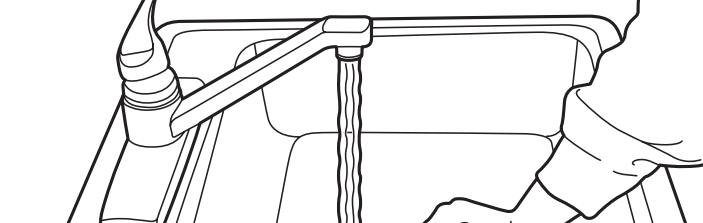

7. CONECTAR EL TRITADOR A LA UNIDAD DE MONTAJE: Precaución: Descarga eléctrica. Retire cualquier objeto que esté dentro de la cámara del triturador antes de instalar el triturador en el fregadero.

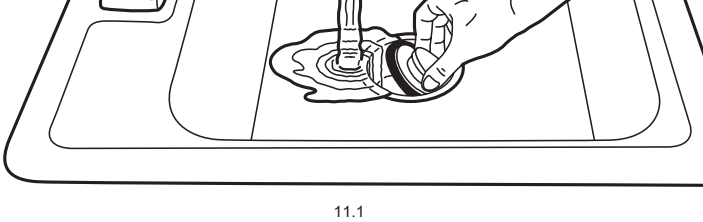

7. CONECTAR EL TRITADOR A LA UNIDAD DE MONTAJE: Precaución: Descarga eléctrica. Retire cualquier objeto que esté dentro de la cámara del triturador antes de instalar el triturador en el fregadero.

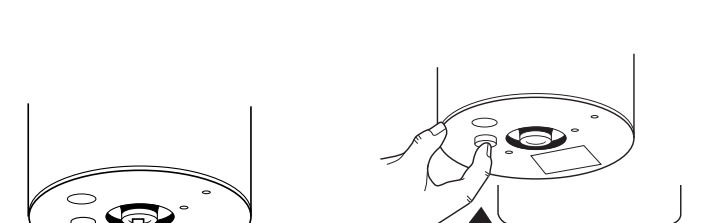

7. CONECTAR EL TRITADOR A LA UNIDAD DE MONTAJE: Precaución: Descarga eléctrica. Retire cualquier objeto que esté dentro de la cámara del triturador antes de instalar el triturador en el fregadero.



7. CONECTAR EL TRITADOR A LA UNIDAD DE MONTAJE: Precaución: Descarga eléctrica. Retire cualquier objeto que esté dentro de la cámara del triturador antes de instalar el triturador en el fregadero.



7. CONECTAR EL TRITADOR A LA UNIDAD DE MONTAJE: Precaución: Descarga eléctrica. Retire cualquier objeto que esté dentro de la cámara del triturador antes de instalar el triturador en el fregadero.



7. CONECTAR EL TRITADOR A LA UNIDAD DE MONTAJE: Precaución: Descarga eléctrica. Retire cualquier objeto que esté dentro de la cámara del triturador antes de instalar el triturador en el fregadero.



7. CONECTAR EL TRITADOR A LA UNIDAD DE MONTAJE: Precaución: Descarga eléctrica. Retire cualquier objeto que esté dentro de la cámara del triturador antes de instalar el triturador en el fregadero.



7. CONECTAR EL TRITADOR A LA UNIDAD DE MONTAJE: Precaución: Descarga eléctrica. Retire cualquier objeto que esté dentro de la cámara del triturador antes de instalar el triturador en el fregadero.

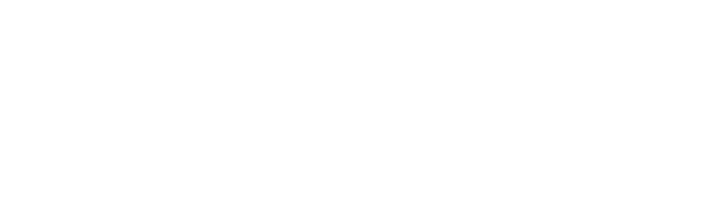

7. CONECTAR EL TRITADOR A LA UNIDAD DE MONTAJE: Precaución: Descarga eléctrica. Retire cualquier objeto que esté dentro de la cámara del triturador antes de instalar el triturador en el fregadero.

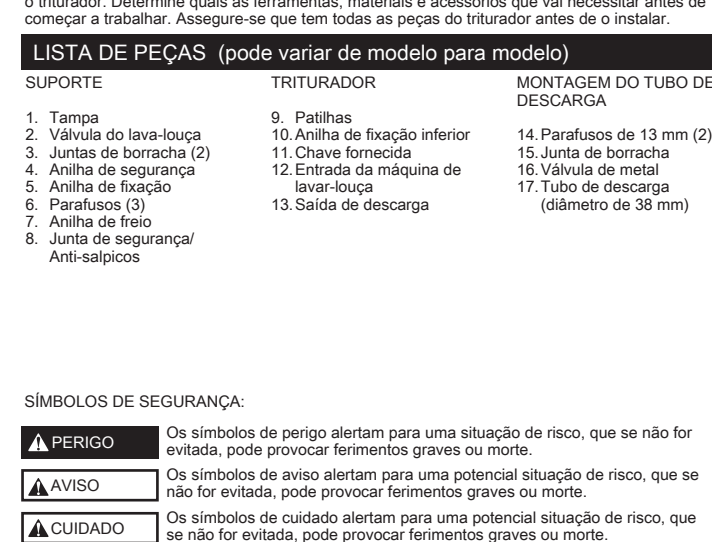
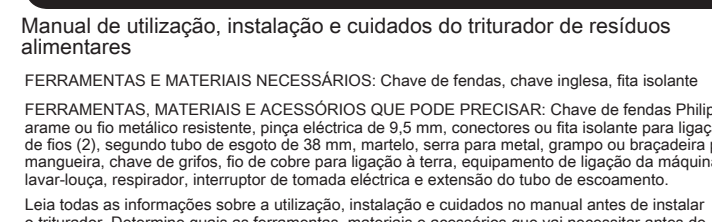

SAFETY SYMBOLS: DANGER indicates an imminently hazardous situation which, if not avoided, will result in death or serious injury.

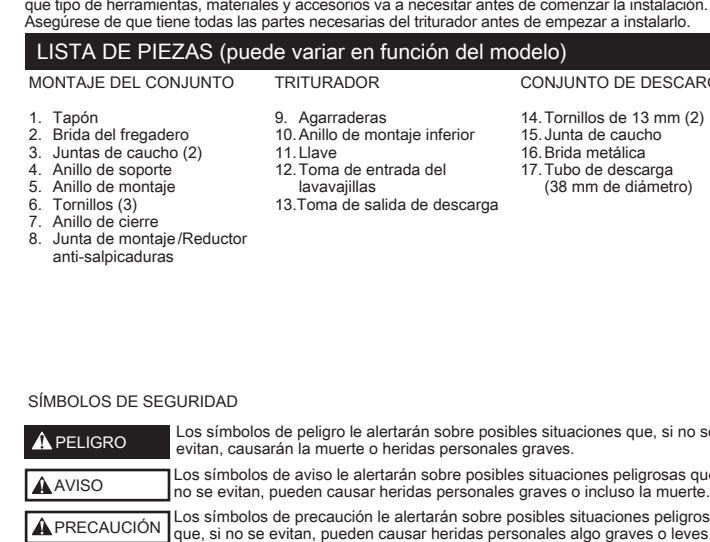
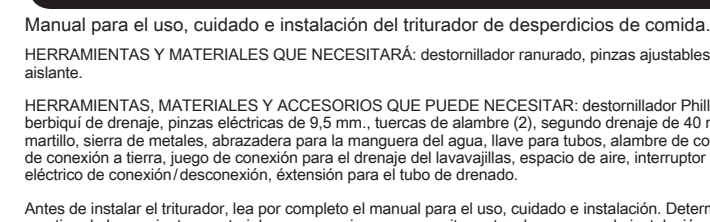
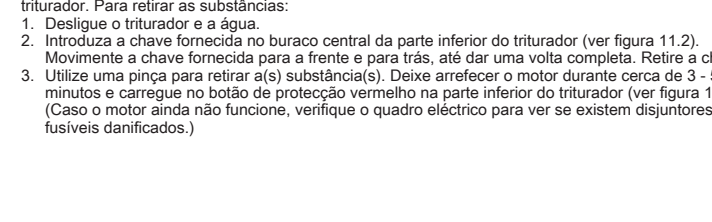
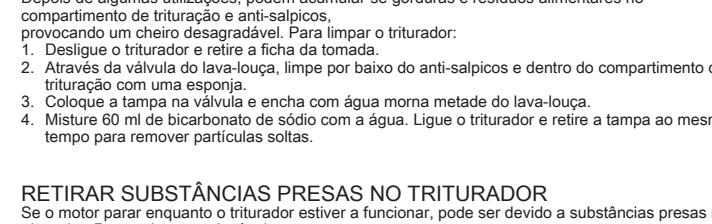
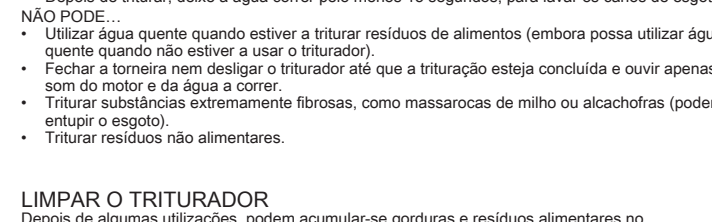
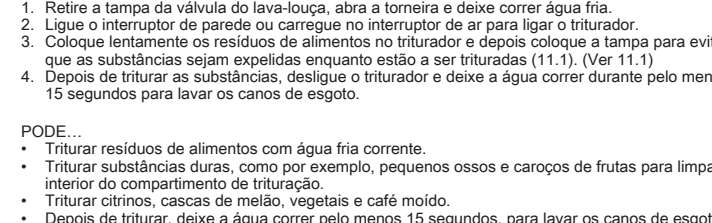
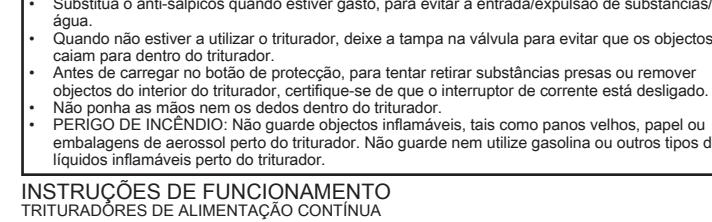
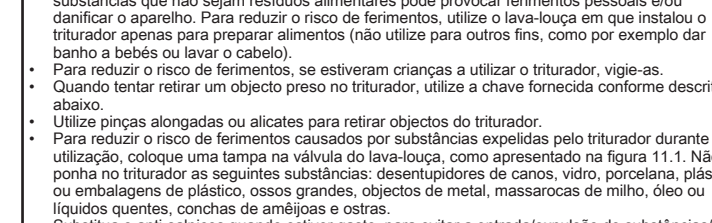
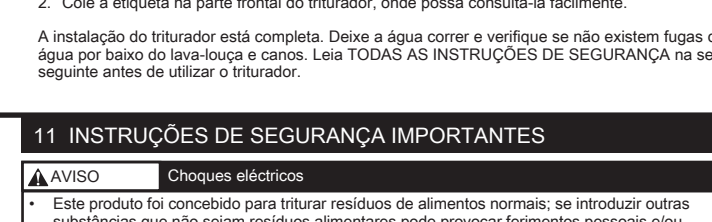
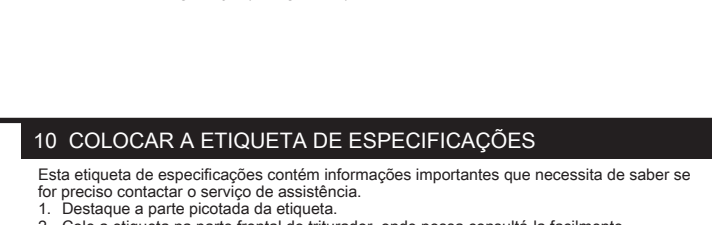
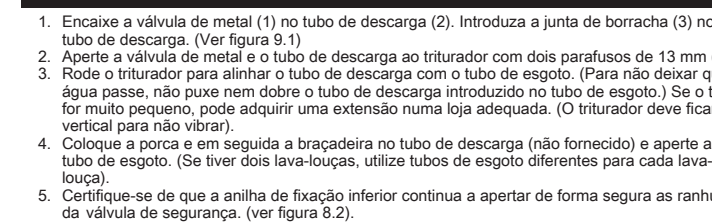
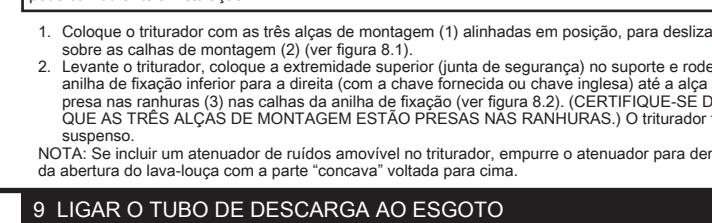
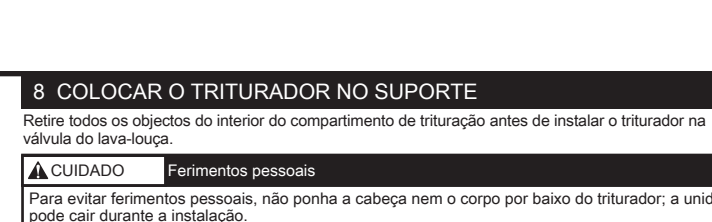
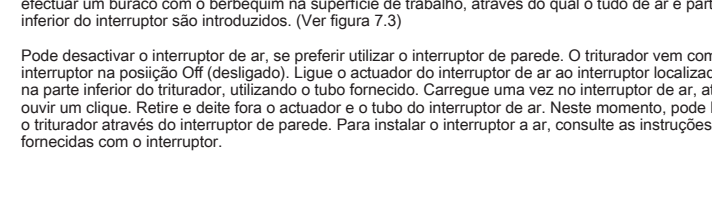
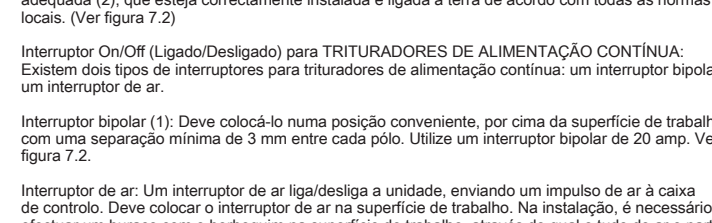
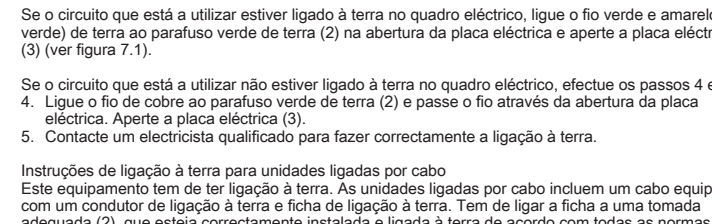
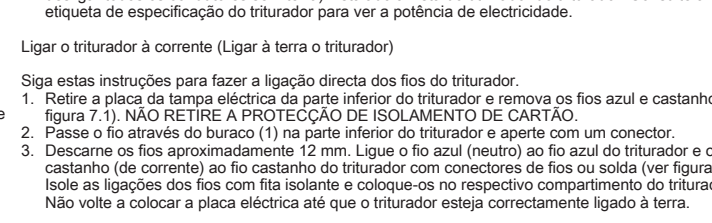
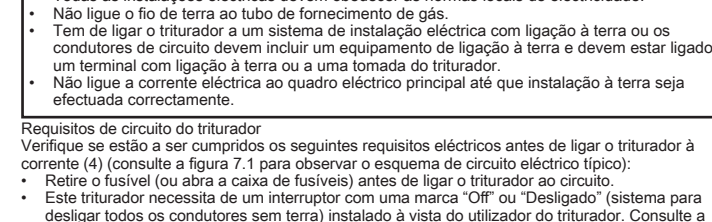
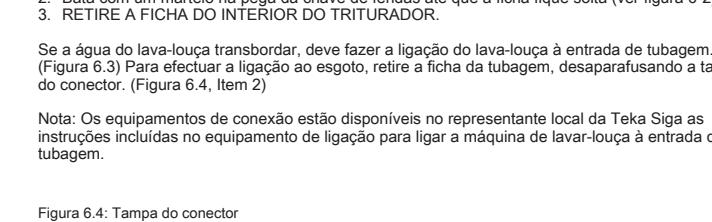
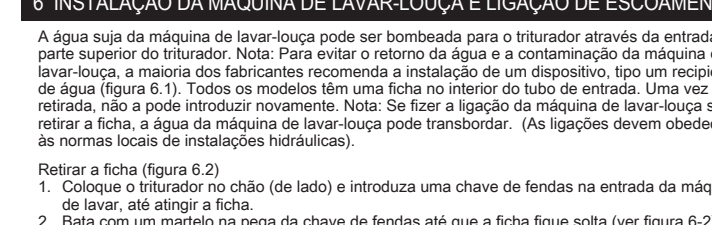
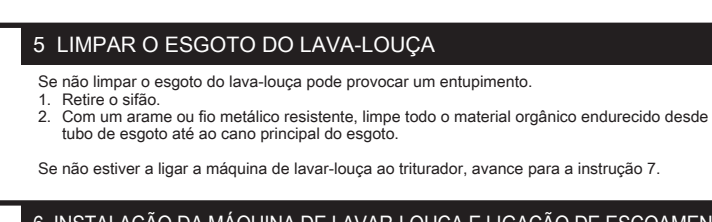
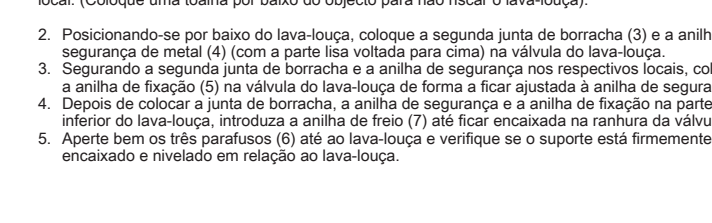
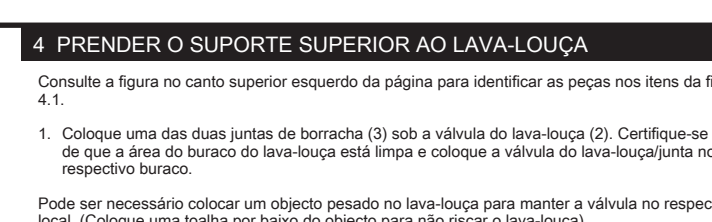
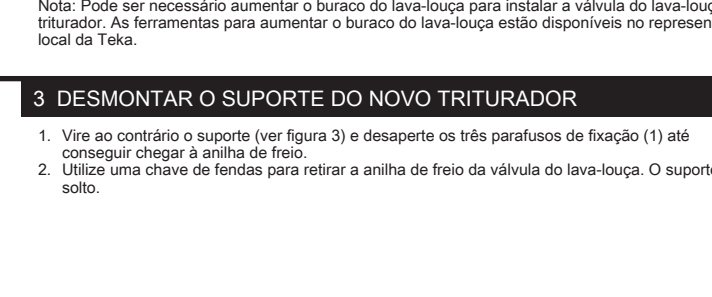
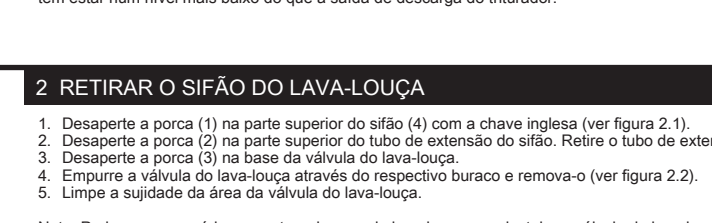

SAFETY SYMBOLS: DANGER indicates an imminently hazardous situation which, if not avoided, will result in death or serious injury.

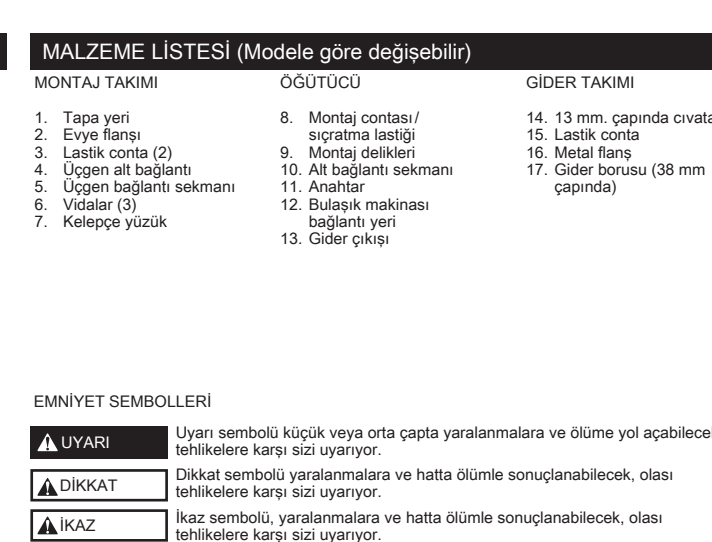
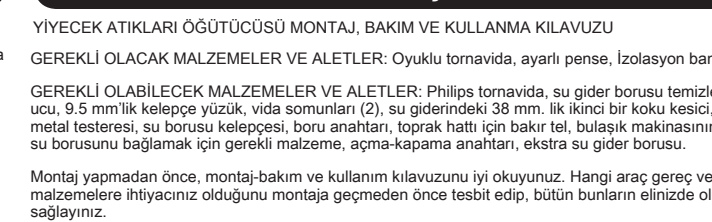
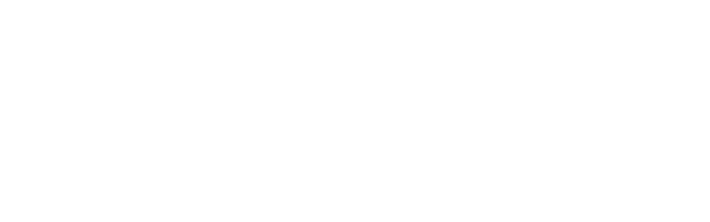
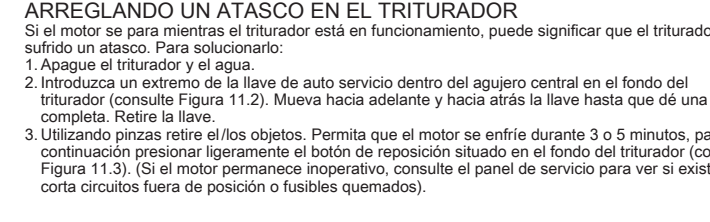
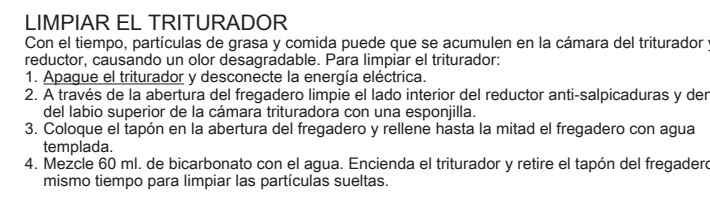
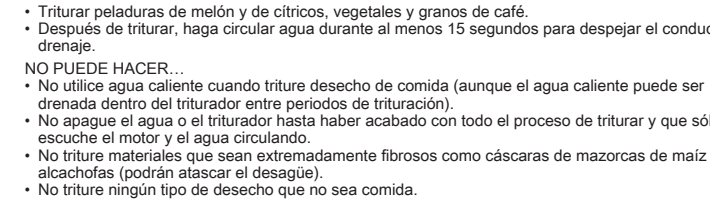
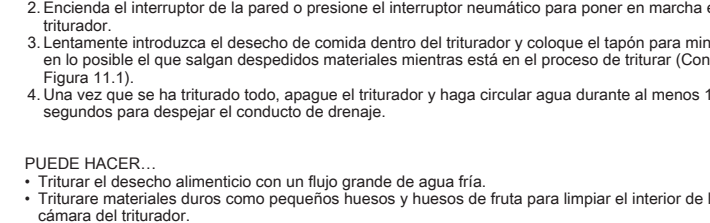
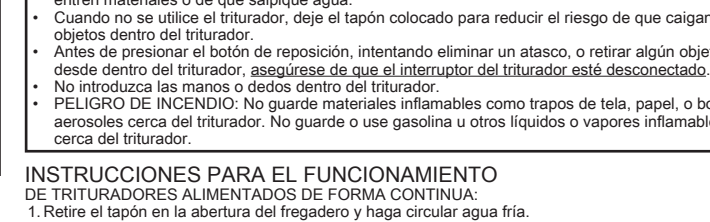
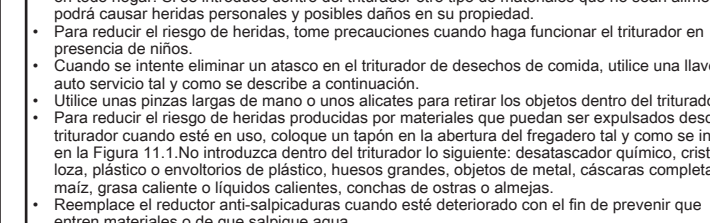
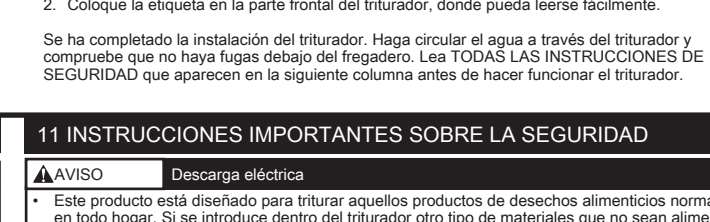
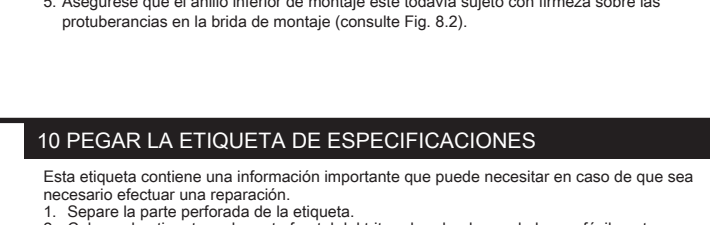
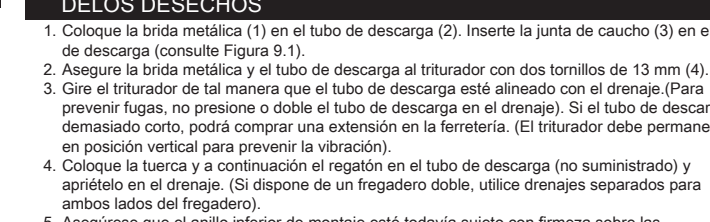
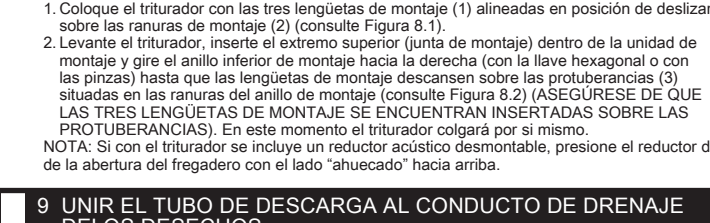
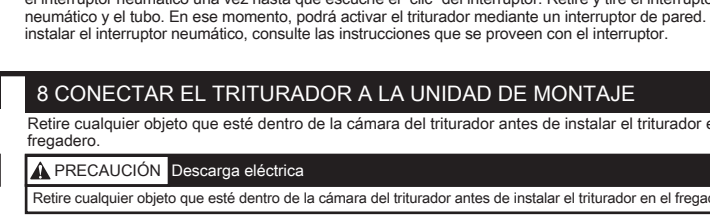
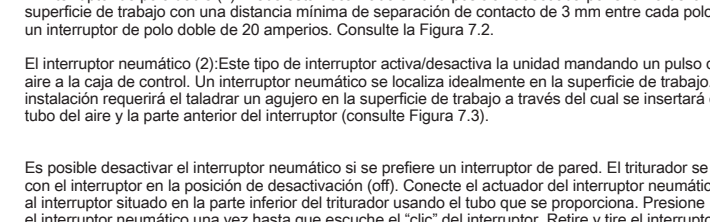
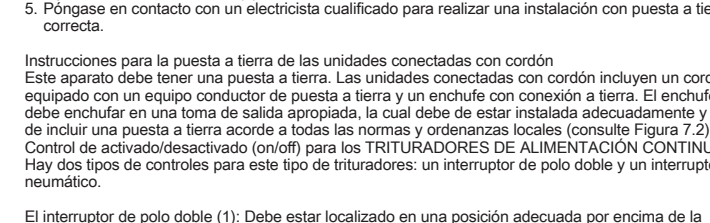
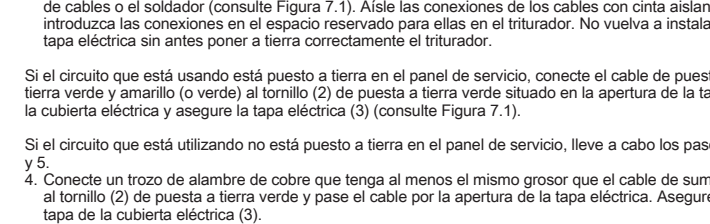
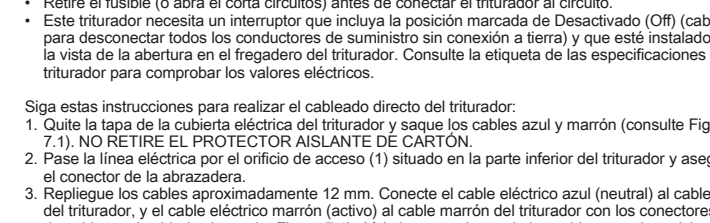
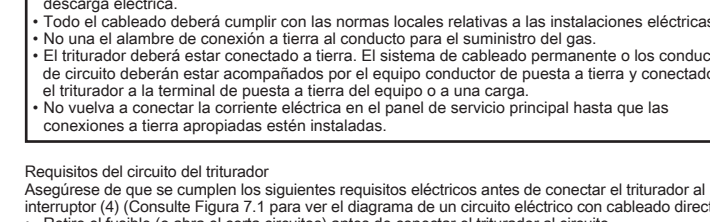
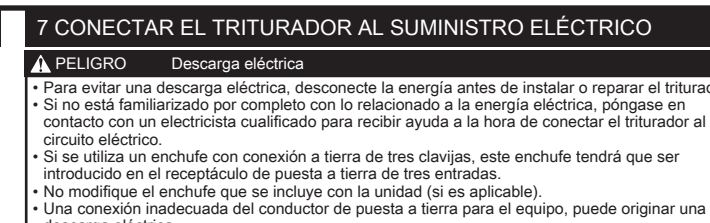
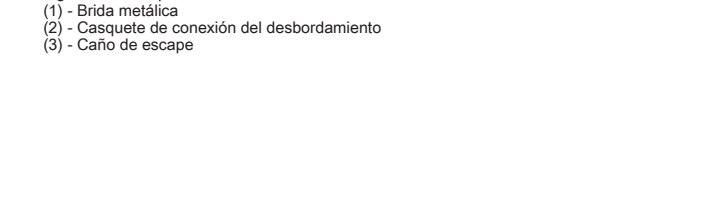
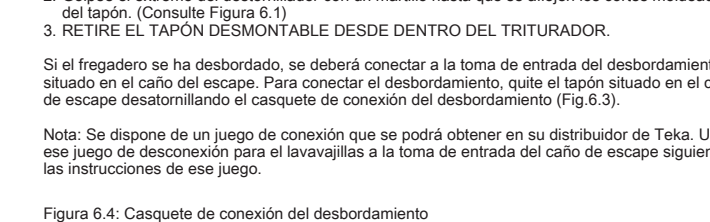
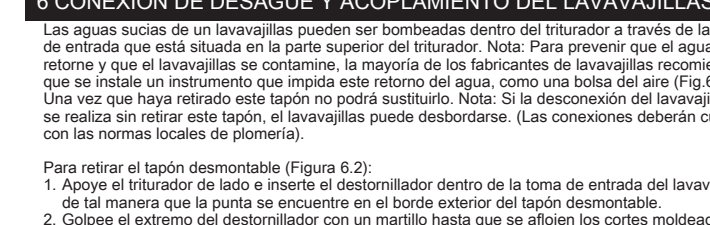
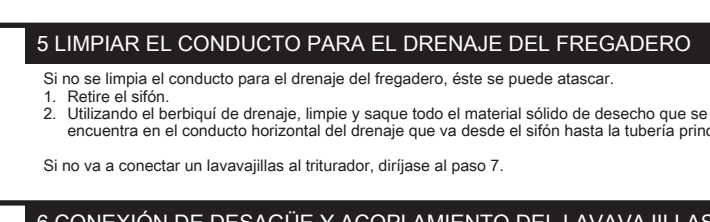
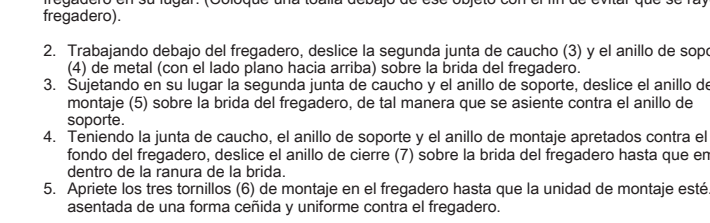
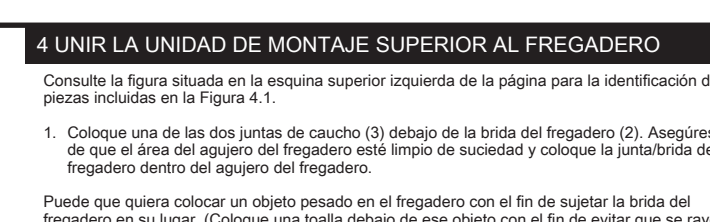
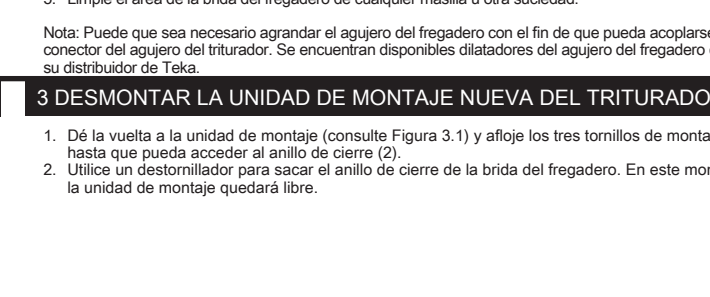
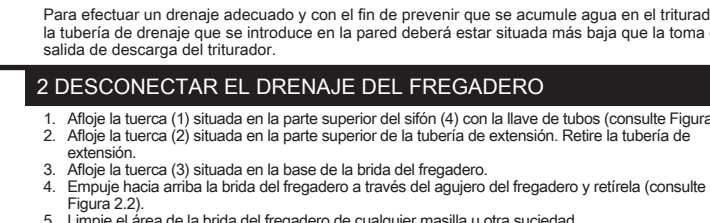

SAFETY SYMBOLS: DANGER indicates an imminently hazardous situation which, if not avoided, will result in death or serious injury.

